

BRITISH INDIA?...

(A New theory on “Indos Ethnicism”)

M.Arulmani, B.E.*, V.R.Hema Latha, M.A., M.Sc., M.Phil.**

* Engineer

** Biologist

1. Abstract:

This scientific research article focus that in the **Global History of Anthropological Science**, the **Ancient human race of India** shall be broadly classified into three Categories. In proto Indo-Europe language these races shall be called as below.

- i) **“KARIAN RACE”** (Indos)
- ii) **“KARNADAN RACE”** (Post Indos)
- iii) **“KARNADAN RACE”** (Ethnic Indos)

It is speculated that the global level Human Races and families belong to various **Ethnicity** shall be considered originated from these fundamental **Two races**. **Karian race** shall mean **Southern race**; **Karnadan Race** shall mean **Northern race**. During the course of time these races shall be considered diversified in east and west direction.

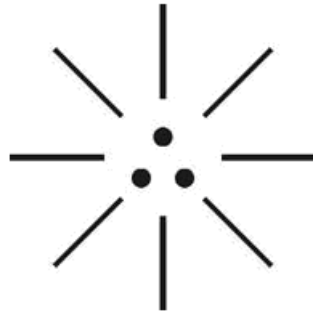

(Three Domain Ethnicism)

- i) Right Dot is like **“EAST INDIES”**
- ii) Left Dot is like **“WEST INDIES”**
- iii) Centre Dot is like **“SOUTH INDIES”**

2.Key Words:

- a) **Mars Human**
- b) **Mars Ape**
- c) **Philosophy of “Indos”**

3.Introduction:

The Ancient India shall be considered as a single large continent and **KARIAN RACE** shall be considered living as a **“Single Large Family”** of India. The **KARNADAN RACE** shall be considered as 2nd Ethnic Race having higher skin colour complexion and considered themselves as **superior race** over **“KARIAN RACE”** and treated them in **“partial way”**. Because of

growing Ethnicity, the Ancient India shall be considered divided into **many states** developing many sub races, which further lead to formation of **many caste based, Religion based society of Globe**. At one stage the “**BRETHREN FOREIGN RULERS**” like “**BRITISH**” invaded India and started ruling India till Independence of “**Republic India**”. Many educational institution, Universities, Major dam constructions, for promoting agriculture. “**MULLAI PERIYAR DAM**” constructed in Tamilnadu by Penny cuick is an example of it.

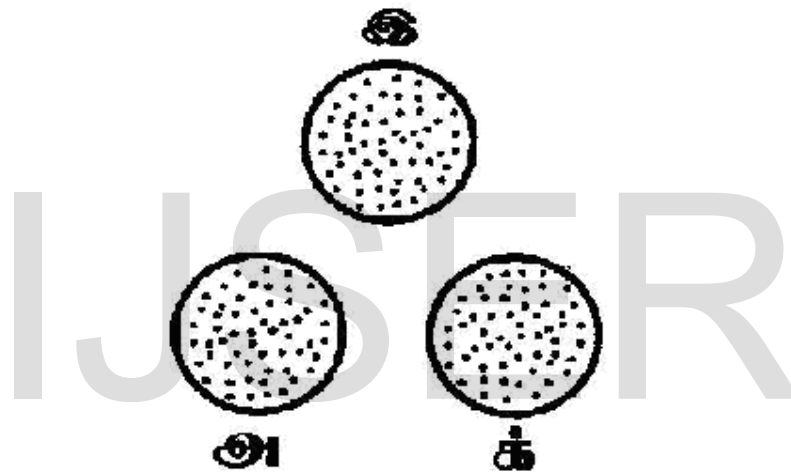

(FAMILIES AND RACES)

4.Hypothesis and Narration

a) **Philosophy of Karnadan Race?...**

It is focused that the **Ancient India** shall be considered as “**Super force Nation**” of the world because of **Unity** and **Oneness** among Indians. The fundamental **Karian Race** shall be of **flying capability** over short distance like **Hen, Peacock** and hence called as “**VANAVAR**”. During the expanding universe, the **Karnadan**

race shall be considered evolved as **genetically varied race** but could not have flying capability and having **gigantic structure** and hence called as **“KING KANGU”**. The Karnadan race shall also be considered as **Tough guy** and **Warrior type** having more **Egoism value** compared to **Karian Race**.



MODEL GIANT SPIDER MAN (KARNADAN RACE)

It is further hypothesized that the impact of genetic value of **“Ancient Ethnicism”** being continued among various states **across the world** till today in various issues such as,

- a) **Unnecessary Fighting with neighboring states for border issue.**
- b) **Non co-operation among lawful sharing river water.**

- c) Non co-operation in implementing Hon'ble Supreme Court Order.**
- d) Non co-operation in implementing Tribunal order of settled issues.**
- e) Jailing the leader who works for the poor.**
- f) Collecting Lakhs of Rupees as legal fees for catching law point.**
- g) Delivering prejudice judgment with gravitational motivation**
- h) Killing of thousands of innocents every day on terrorism**
- i) Killing of beloved children for the cause of inter cast marriage**
- j) Torturing the daughter-in-law for childless womb**



SON OF THE SOIL... GOD'S OWN COUNTRY...
(King of King)

*The **WORLD** is like a **MEGA JAIL** constructed over the surface of the **EARTH**. Every one considered living in **DIFFERENT CELL** in different region as **ACCUSED** until error free judgment by **SUPERNATURE (GOD)** based on good deeds and action*

- M. Arulmani, Tamil Based Indian

b) Philosophy of “Kannian Race”?...

It is hypothesized that “**Kannian Race**” shall be considered as prehistoric **Alien Race** descended from “**WHITE MARS** (also called as **White Planet**). The Kannian race shall also be considered as belong to **Angel Family** having distinguished genetic value. The angel family shall be considered not giving much important to the **FOOD**.

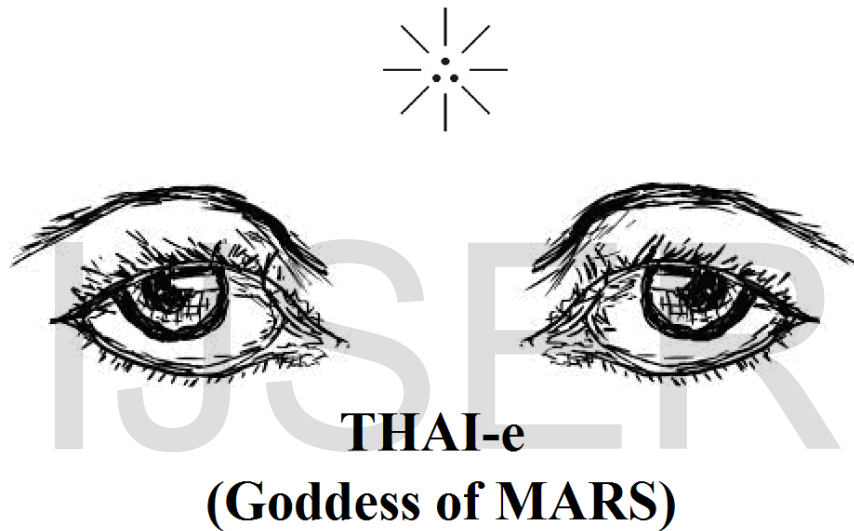

“Little bread and red wine is sufficient for sustainability of life rather than sambar, rasam, poriyal, chikcn-65, mutton cola, curry meen, French scotch”

- Author

c) Philosophy of Mars Human?...

It is hypothesized that in the early universe **life organism** considered originated and lived in **white mars** such as **Mars human, Mars Ape, Mars plant** (Marijunna) having only **three chromosome origin** (Trisomy) and subsequently the seeds considered descended to **earth planet** at later stage.

(i)

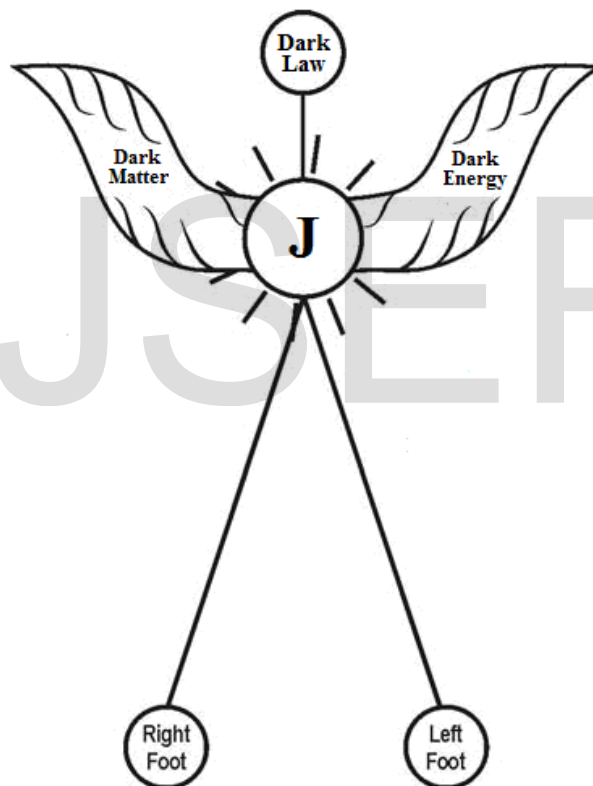

VANAVAR
(MARS Human)

(ii)

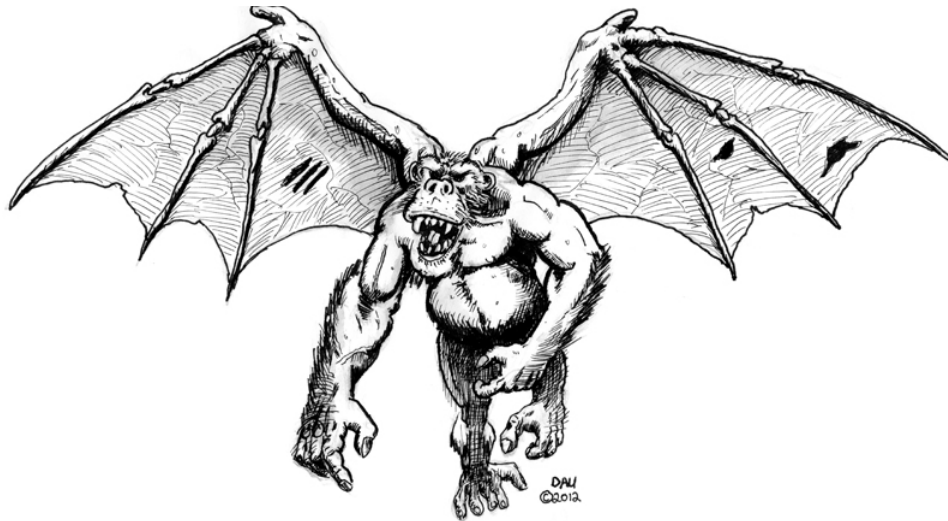

**PLAIN APE
(MARS APE)**

d) Politics differs from law?...

It is hypothesized that politics rule, law shall be considered as having distinguished meaning in system law of life.

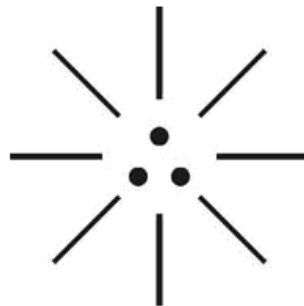

**UNIVERSAL LAW CODE
(Natural Justice)**

- i) Right dot is like **“SACRIFICE”** (like DNA)
- ii) Left dot is like **“POLITICS”** (like Hormone)

- iii) Center dot is like “**INTUITION**” (like RNA)
- iv) J-Radiation – “**LAW**”

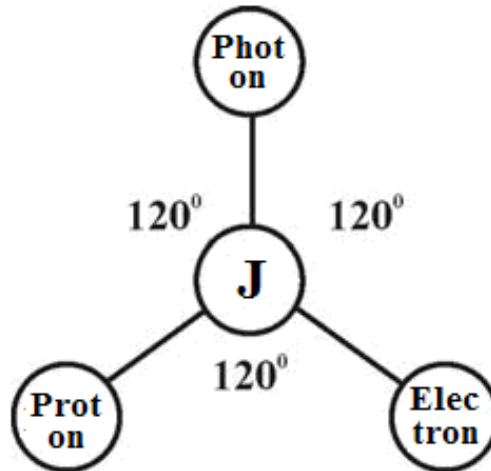

(LAW OF UNIVERSE)

IJSER

***EARTH QUAKE, CYCLONE, FOREST FIRE SHALL BE
CONSIDERED AS NATURAL JUSTICE RATHER THAN
JUDGMENT OR JUSTICE OFFERED BY HUMAN
FELLOW***

- Author

e) Philosophy of “INDOS”?...

Case study shows that Indus valley civilization is considered as oldest civilization dated back to around 3000BC. It is

hypothesized that Indus valley civilization shall be considered as pertains to second Generation of human race say “**KARNADAN RACE**” pertain to around 1,00,000 years back. Further the etymology of word “**INDOS**”, “**INDUS**” might be derived from the proto Indo-Europe language root “**ETHIA**”.

சமர்ப்பணம்

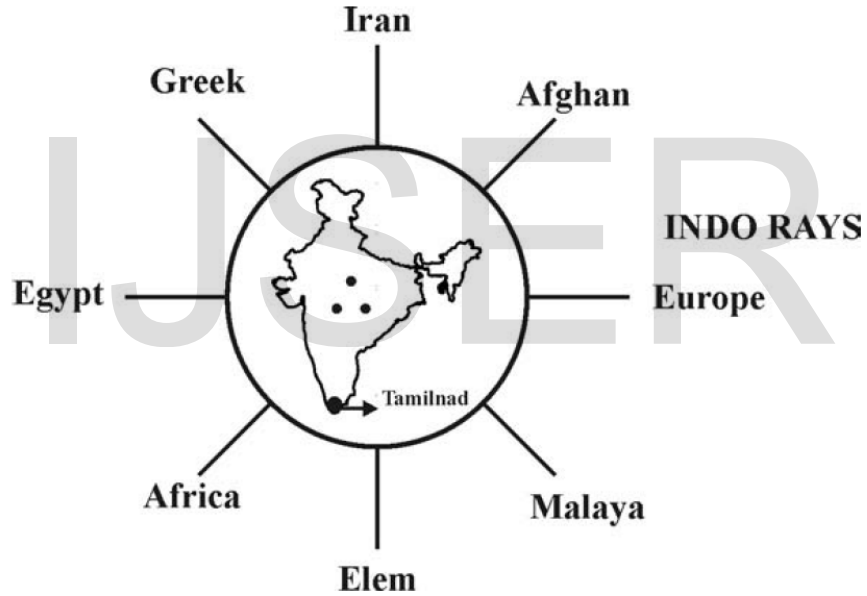

“ இந்தியநாடு என் தாய்;
தமிழ்நாடு என்தாயின் பாதஅடி.
என் தாயின் பாத அடியில் இப்புத்தக அஞ்சலி ”

ஆசிரியர்

தமிழ்ப்பேசும் இந்தியன்

f) Adolf Hitler is an Indos?...

Case study shows that Adolf Hitler is an Australian born and German politician who is the leader of Nazi party. It is hypothesized that Adolf Hitler shall be considered as post Indos race say **“KARNADAN RACE”**.

5. Conclusion:

It is focused that in Anthropological language the genetically varied **three most fundamental human race** shall be described as below. Further **Ancient India** (Pronounced as **Ethia**) shall be considered as **“Mother of all Earthly Nations”**.

- i) **“Kannian Race”** shall mean **“GOD” (Endos)**
- ii) **“Karian Race”** shall mean **“KING” (Indos)**
- iii) **“Karnadan Race”** shall mean **“KINGKANGU” (Post Indos)**

6. Previous Publication:

The philosophy of origin of first life and human, the philosophy of model Cosmo Universe, the philosophy of fundamental neutrino particles have already been published in various international journals mentioned below. Hence this article shall be considered as **extended version** of the previous articles already published by the same author.

- [1] Cosmo Super Star – IJSRP, April issue, 2013
- [2] Super Scientist of Climate control – IJSER, May issue, 2013
- [3] AKKIE MARS CODE – IJSER, June issue, 2013
- [4] KARITHIRI (Dark flame) The Centromere of Cosmo Universe – IJIRD, May issue, 2013
- [5] MA-AYYAN of MARS – IJIRD, June issue, 2013
- [6] MARS TRIBE – IJSER, June issue, 2013
- [7] MARS MATHEMATICS – IJERD, June issue, 2013
- [8] MARS (EZHEM) The mother of All Planets – IJSER, June issue, 2013
- [9] The Mystery of Crop Circle – IJOART, May issue, 2013
- [10] Origin of First Language – IJIRD, June issue, 2013
- [11] MARS TRISOMY HUMAN – IJOART, June issue, 2013
- [12] MARS ANGEL – IJSTR, June issue, 2013
- [13] Three principles of Akkie Management (AJIBM, August issue, 2013)
- [14] Prehistoric Triphthong Alphabet (IJIRD, July issue, 2013)
- [15] Prehistoric Akkie Music (IJST, July issue, 2013)
- [16] Barack Obama is Tamil Based Indian? (IJSER, August issue, 2013)
- [17] Philosophy of MARS Radiation (IJSER, August 2013)
- [18] Etymology of word “**J**” (IJSER, September 2013)
- [19] NOAH is Dravidian? (IJOART, August 2013)
- [20] Philosophy of Dark Cell (Soul)? (IJSER, September 2013)
- [21] Darwin Sir is Wrong?! (IJSER, October issue, 2013)
- [22] Prehistoric Pyramids are RF Antenna?!... (IJSER, October issue, 2013)
- [23] HUMAN IS A ROAM FREE CELL PHONE?!... (IJIRD, September issue, 2013)
- [24] NEUTRINOS EXIST IN EARTH ATMOSPHERE?!... (IJERD, October issue, 2013)

- [25] EARLY UNIVERSE WAS HIGHLY FROZEN?!... (IJOART, October issue, 2013)
- [26] UNIVERSE IS LIKE SPACE SHIP?!... (AJER, October issue, 2013)
- [27] ANCIENT EGYPT IS DRAVIDA NAD?!... (IJSER, November issue, 2013)
- [28] ROSETTA STONE IS PREHISTORIC “THAMEE STONE”?!... (IJSER, November issue, 2013)
- [29] The Supernatural “CNO” HUMAN?... (IJOART, December issue, 2013)
- [30] 3G HUMAN ANCESTOR?... (AJER, December issue, 2013)
- [31] 3G Evolution?... (IJIRD, December issue, 2013)
- [32] God Created Human?... (IJERD, December issue, 2013)
- [33] Prehistoric “J” – Element?... (IJSER, January issue, 2014)
- [34] 3G Mobile phone Induces Cancer?... (IJERD, December issue, 2013)
- [35] “J” Shall Mean “JOULE”?... (IRJES, December issue, 2013)
- [36] “J”- HOUSE IS A HEAVEN?... (IJIRD, January issue, 2014)
- [37] The Supersonic JET FLIGHT-2014?... (IJSER, January issue, 2014)
- [38] “J”-RADIATION IS MOTHER OF HYDROGEN?... (AJER, January issue, 2014)
- [39] PEACE BEGINS WITH “J”?... (IJERD, January issue, 2014)
- [40] THE VIRGIN LIGHT?... (IJCRAR, January issue 2014)
- [41] THE VEILED MOTHER?... (IJERD, January issue 2014)
- [42] GOD HAS NO LUNGS?... (IJERD, February issue 2014)
- [43] Matters are made of Light or Atom?!... (IJERD, February issue 2014)
- [44] THE NUCLEAR “MUKKULAM”?... (IJSER, February issue 2014)

- [45] WHITE REVOLUTION 2014-15?... (IJERD, February issue 2014)
- [46] STAR TWINKLES!?... (IJERD, March issue 2014)
- [47] “E-LANKA” THE TAMIL CONTINENT?... (IJERD, March issue 2014)
- [48] HELLO NAMESTE?... (IJSER, March issue 2014)
- [49] MOTHERHOOD MEANS DELIVERING CHILD?... (AJER, March issue 2014)
- [50] E-ACHI, IAS?... (AJER, March issue 2014)
- [51] THE ALTERNATIVE MEDICINE?... (AJER, April issue 2014)
- [52] GANJA IS ILLEGAL PLANT?... (IJERD, April issue 2014)
- [53] THE ENDOS?... (IJERD, April issue 2014)
- [54] THE “TRI-TRONIC” UNIVERSE?... (AJER, May issue 2014)
- [55] Varied Plasma Level have impact on “GENETIC VALUE”?... (AJER, May issue 2014)
- [56] JALLIKATTU IS DRAVIDIAN VETERAN SPORT?... (AJER, May issue 2014)
- [57] Human Equivalent of Cosmo?... (IJSER, May issue 2014)
- [58] THAI-e ETHIA!... (AJER, May issue 2014)
- [59] THE PHILOSOPHY OF “DALIT”?... (AJER, June issue 2014)
- [60] THE IMPACT OF HIGHER QUALIFICATION?... (AJER, June issue 2014)
- [61] THE CRYSTAL UNIVERSE?... (AJER July 2014 issue)
- [62] THE GLOBAL POLITICS?... (AJER July 2014 issue)
- [63] THE KACHCHA THEEVU?... (AJER July 2014 issue)
- [64] THE RADIANT MANAGER?... (AJER July 2014 issue)
- [65] THE UNIVERSAL LAMP?... (IJOART July 2014 issue)
- [66] THE MUSIC RAIN?... (IJERD July 2014 issue)
- [67] THIRI KURAL?... (AJER August 2014 issue)

- [68] THE SIXTH SENSE OF HUMAN?... (AJER August 2014 issue)
- [69] THEE... DARK BOMB?... (IJSER August 2014 issue)
- [70] RAKSHA BANDHAN CULTURE?... (IJERD August 2014 issue)
- [71] THE WHITE BLOOD ANCESTOR?... (AJER August 2014 issue)
- [72] THE PHILOSOPHY OF “ZERO HOUR”?... (IJERD August 2014 issue)
- [73] RAMAR PALAM?... (AJER September 2014 issue)
- [74] THE UNIVERSAL TERRORIST?... (AJER September 2014 issue)
- [75] THE “J-CLOCK”!... (AJER September 2014 issue)
- [76] “STUDENTS” AND “POLITICS”?... (IJERD October 2014 issue)
- [77] THE PREGNANT MAN?... (AJER September 2014 issue)
- [78] PERIAR IS ATHEIST?... (IJSER September 2014 issue)
- [79] A JOURNEY TO "WHITE PLANET"?... (AJER October 2014 issue)
- [80] Coming Soon!... (AJER October 2014 issue)
- [81] THE PREJUDICED JUSTICE?... (IJERD October 2014 issue)

7. REFERENCE

- a) Intensive Internet “e-book” study through, Google search and wikipedia
- b) M.Arulmani, “3G Akkanna Man”, Annai Publications, Cholapuram, 2011
- c) M. Arulmani; V.R. Hemalatha, “Tamil the Law of Universe”, Annai Publications, Cholapuram, 2012
- d) Harold Koontz, Heinz Weihriah, “Essentials of management”, Tata McGraw-Hill publications, 2005
- e) M. Arulmani; V.R. Hemalatha, “First Music and First Music Alphabet”, Annai Publications, Cholapuram, 2012
- f) King James Version, “Holy Bible”

- g) S.A. Perumal, "Human Evolution History"
- h) "English Dictionary", Oxford Publications
- i) Sho. Devaneyapavanar, "Tamil first mother language", Chennai, 2009
- j) Tamilannal, "Tholkoppiar", Chennai, 2007
- k) "Tamil to English Dictionary", Suravin Publication, 2009
- l) "Text Material for E5 to E6 upgradaton", BSNL Publication, 2012
- m) A. Nakkiran, "Dravidian mother", Chennai, 2007
- n) Dr. M. Karunanidhi, "Thirukkural Translation", 2010
- o) "Manorama Tell me why periodicals", M.M. Publication Ltd., Kottayam, 2009
- p) V.R. Hemalatha, "A Global level peace tourism to Veilankanni", Annai Publications, Cholapuram, 2007
- q) Prof. Ganapathi Pillai, "Sri Lankan Tamil History", 2004
- r) Dr. K.K. Pillai, "South Indian History", 2006
- s) M. Varadharajan, "Language History", Chennai, 2009
- t) Fr. Y.S. Yagoo, "Western Sun", 2008
- u) Gopal Chettiar, "Adi Dravidian Origin History", 2004
- v) M. Arulmani; V.R. Hemalatha, "Ezhem Nadu My Dream" - (2 Parts), Annai Publications, Cholapuram, 2010
- w) M. Arulmani; V.R. Hemalatha, "The Super Scientist of Climate Control", Annai Publications, Cholapuram, 2013, pp 1-3

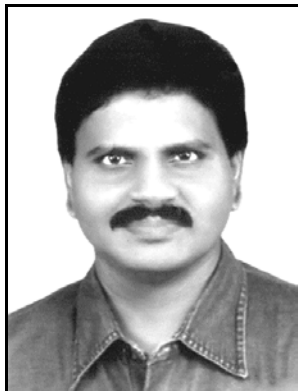

M.Arulmani, B.E.
(Engineer)
m.arulmani58@gmail.com



V.R.Hema Latha, M.A.,
M.Sc., M.Phil.
(Biologist)
vrhemalatha58@gmail.com

IJSER